



**50Ω TERMINATED 18 GHz SMA FAILSAFE D.P.3.T. SWITCH**

OPTIONS : INDICATOR / TTL DRIVE

**R F CHARACTERISTICS**

FREQUENCY RANGE : 0 - 18 GHz  
 IMPEDANCE : 50 Ohms

FREQUENCY (GHz)	0 - 3	3 - 8	8 -12.4	12.4- 18
V.S.W.R <=	1.20	1.30	1.40	1.50
INSERT. LOSS <=	0.20 dB	0.30 dB	0.40 dB	0.50 dB
ISOLATION >=	80 dB	70 dB	60 dB	60 dB
AVER. POWER (*)	240 W	150 W	120 W	100 W

**ELECTRICAL CHARACTERISTICS**

ACTUATOR : FAILSAFE  
 NOMINAL CURRENT AT 25° C (±10%) : 204 mA  
 ACTUATOR VOLTAGE (Vcc) : 28V (24 to 30V)  
 TERMINALS : solder pins (250° C max./30 sec.)  
 INDICATOR RATING : 1 W / 30 V / 100 mA  
 TTL INPUTS (E) - High level : 2.2 to 5.5V / 800µA at 5V  
 - Low level : 0 to 0.8V / 20µA at 0.8V

**MECHANICAL CHARACTERISTICS**

CONNECTORS : SMA female per MIL C 39012  
 LIFE : 10.000.000 cycles  
 SWITCHING TIME (nominal voltage;25° C) : < 10 ms  
 CONSTRUCTION : splashproof  
 WEIGHT : < 100 g

**ENVIRONMENTAL CHARACTERISTICS**

OPERATING TEMPERATURE RANGE (°C) : -40 , +85  
 STORAGE TEMPERATURE RANGE (°C) : -55 , +85

(\* : average power at 25° C)

This information is given as an indication. In the continual goal to improve our products, we reserve the right to make any modifications judged necessary

4112-9212

**DRAWING**

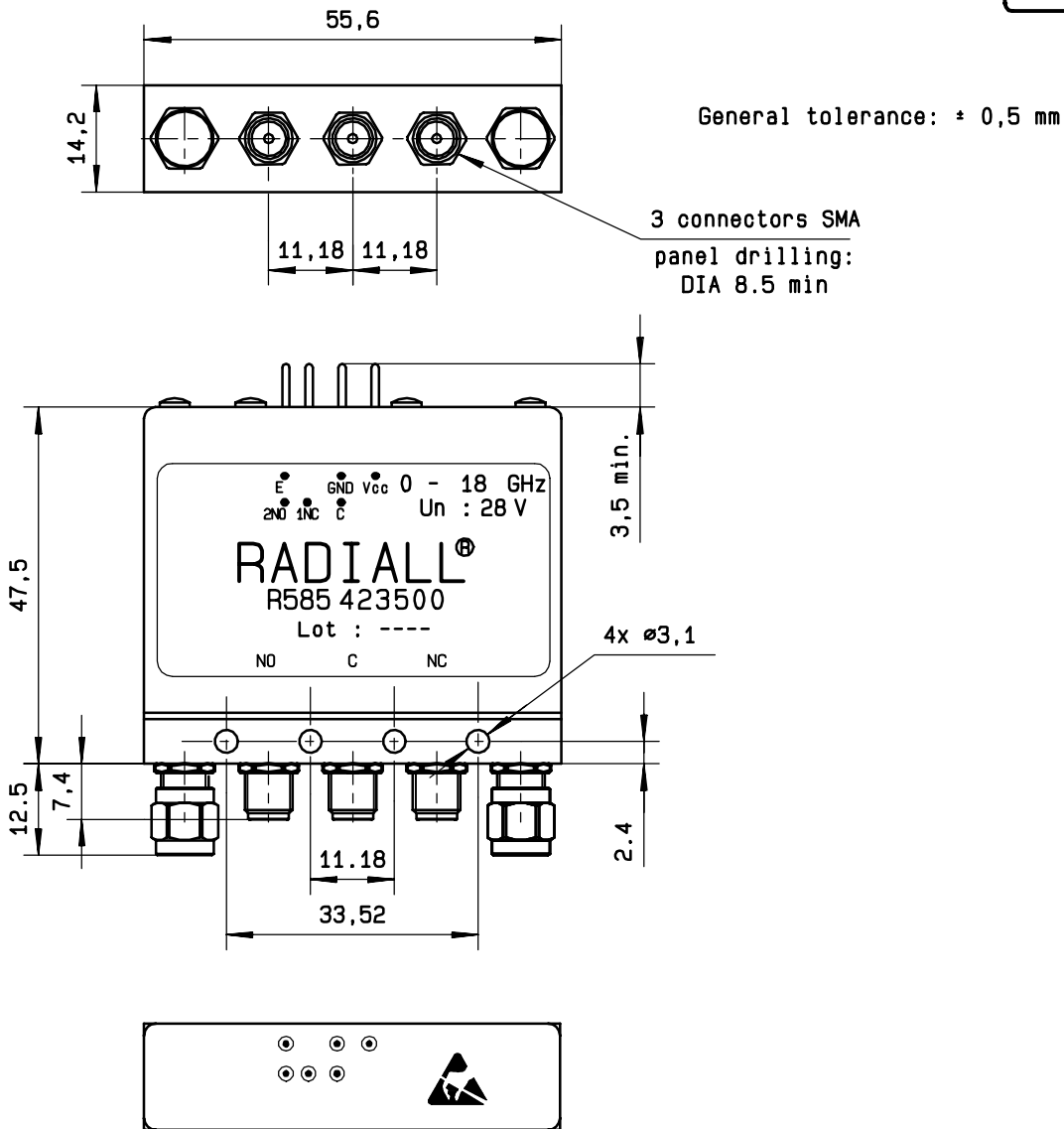

**SCHEMATIC DIAGRAM**

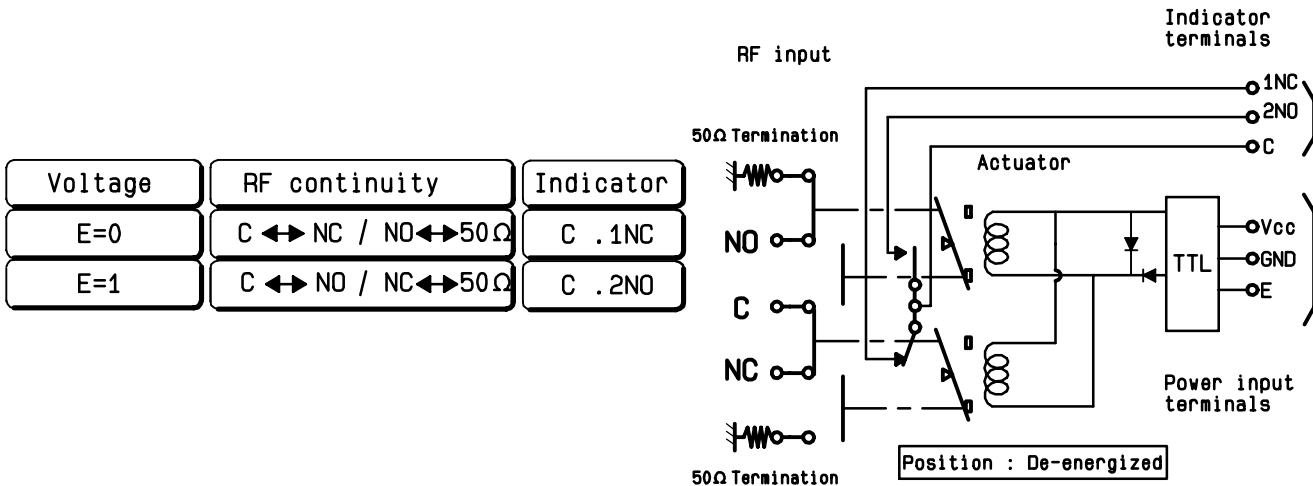

4113-9212 This information is given as an indication. In the continual goal to improve our products, we reserve the right to make any modifications judged necessary